

Benabec

Architectural Products

Product Catalogue

*Designers & Manufacturers of
Quality Cast Stone Elements*



www.Benabec.com

(519) 624-0766

Benabec

Architectural Products

Table of Contents

Architectural Products

Banding

Fireplaces (Mantels & Surrounds)

Foils

Headers

Keystones

Post Caps

Sills

Step Treads

Surrounds (Doors & Windows)

Thresholds

Wallcapping

Watertables

Collections

Specifications

Notes & Sketches

Custom profiles and sizes available.

Benabec

Architectural Products

Banding

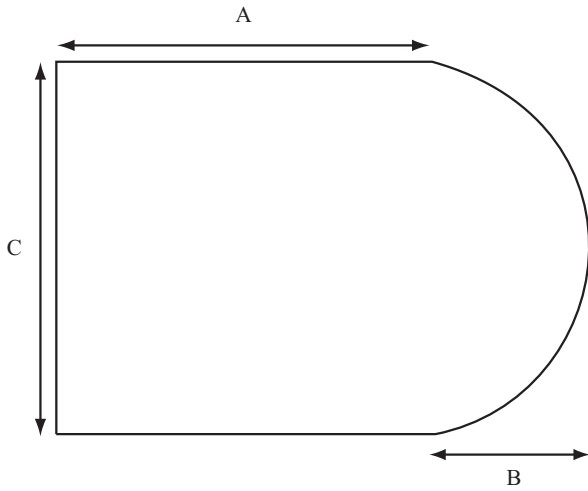

Item #	A	B	C
BG 001-3	3 5/8	1 1/2	3 5/8
BG 001-4	3 5/8	2	4 5/8
BG 001-5	3 5/8	2 13/32	5 5/8
BG 001-7	3 5/8	3 1/4	7 5/8

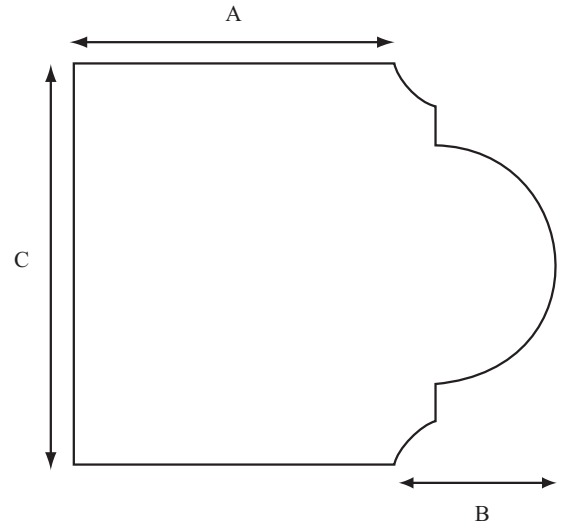

Item #	A	B	C
BG 002-3	3 5/8	1 3/8	3 5/8
BG 002-4	3 5/8	1 7/8	4 5/8
BG 002-5	3 5/8	2 1/4	5 5/8
BG 002-7	3 5/8	3	7 5/8

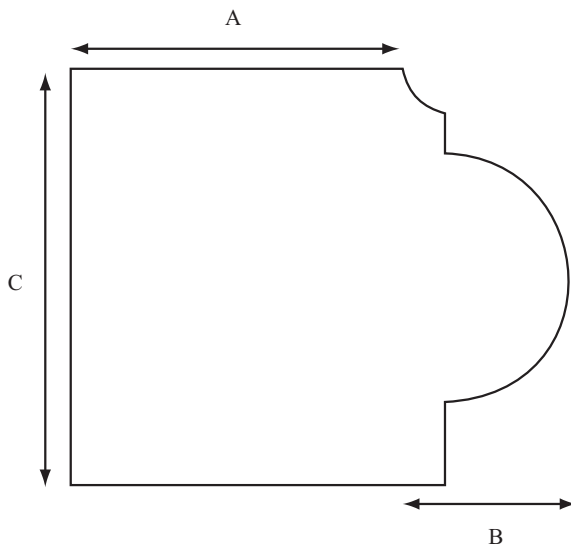

Item #	A	B	C
BG 003-3	3 5/8	1 3/8	3 5/8
BG 003-4	3 5/8	1 7/8	4 5/8
BG 003-5	3 5/8	2 1/4	5 5/8
BG 003-7	3 5/8	3	7 5/8

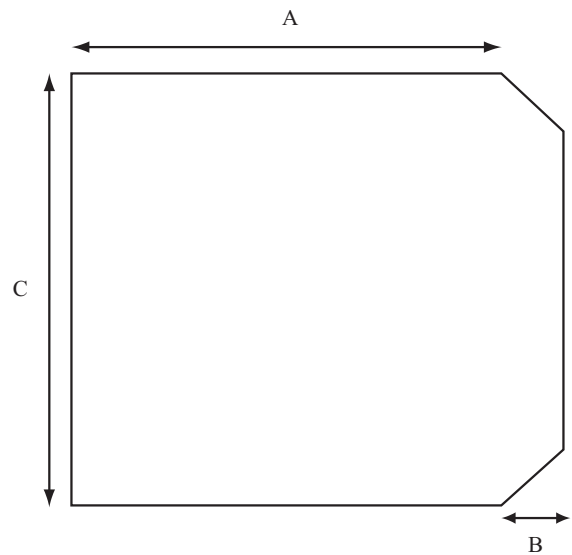

Item #	A	B	C
BG 004-3	3 5/8	1/2	3 5/8
BG 004-4	3 5/8	11/16	4 5/8
BG 004-5	3 5/8	13/16	5 5/8
BG 004-7	3 5/8	1	7 5/8

Custom profiles and sizes available.

Benabec

Architectural Products

Banding

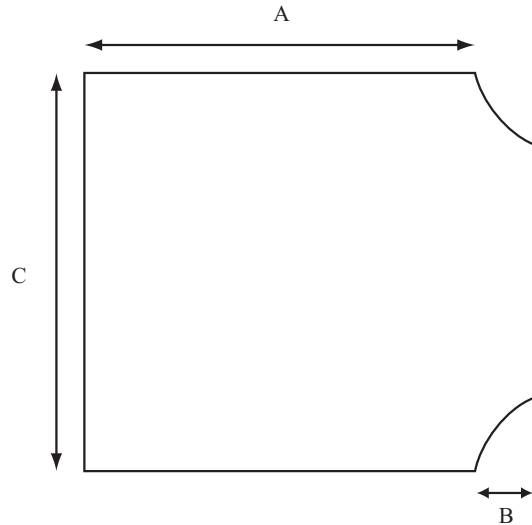
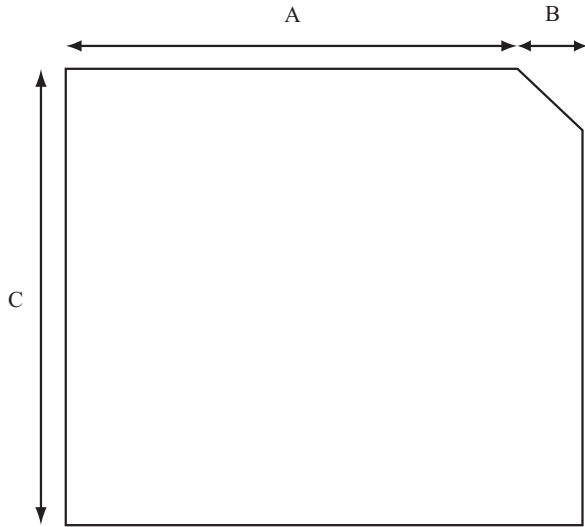

Item #	A	B	C
BG 005-3	3 5/8	1/2	3 5/8
BG 005-4	3 5/8	11/16	4 5/8
BG 005-5	3 5/8	13/16	5 5/8
BG 005-7	3 5/8	1	7 5/8

Item #	A	B	C
BG 006-3	3 5/8	1/2	3 5/8
BG 006-4	3 5/8	3/4	4 5/8
BG 006-5	3 5/8	3/4	5 5/8
BG 006-7	3 5/8	1	7 5/8

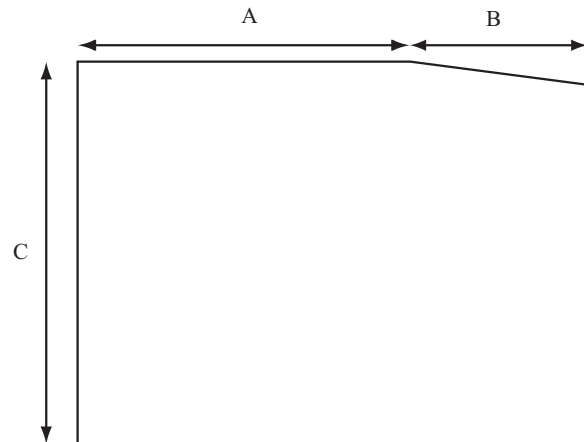
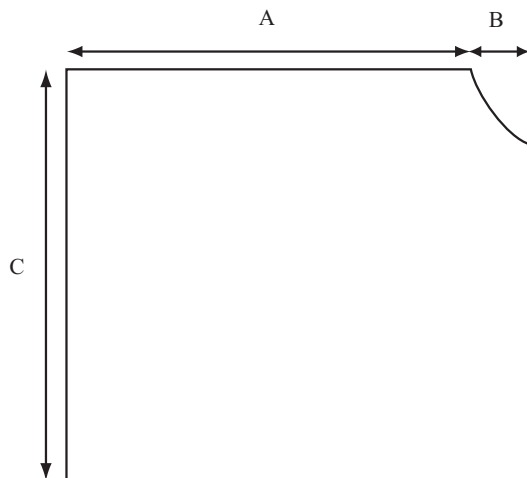

Item #	A	B	C
BG 007-3	3 5/8	1/2	3 5/8
BG 007-4	3 5/8	3/4	4 5/8
BG 007-5	3 5/8	3/4	5 5/8
BG 007-7	3 5/8	3/4	7 7/8

Item #	A	B	C
BG 012-4	3 5/8	2	4 1/4
BG 012-9	3 5/8	2	9

Other Sizes Available

Custom profiles and sizes available.

Benabec

Architectural Products

Banding

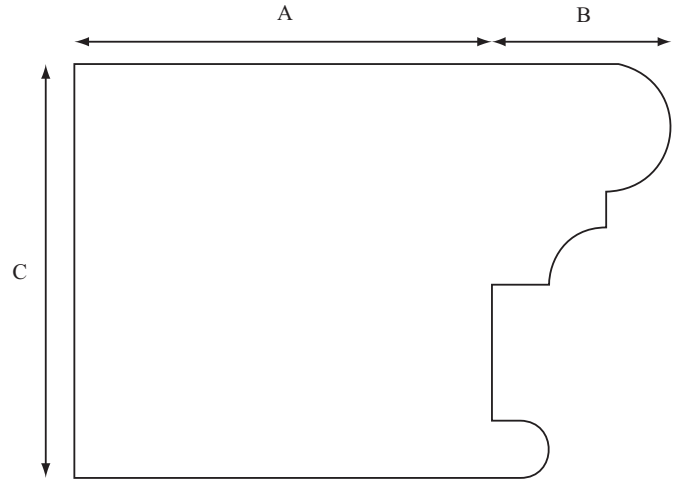
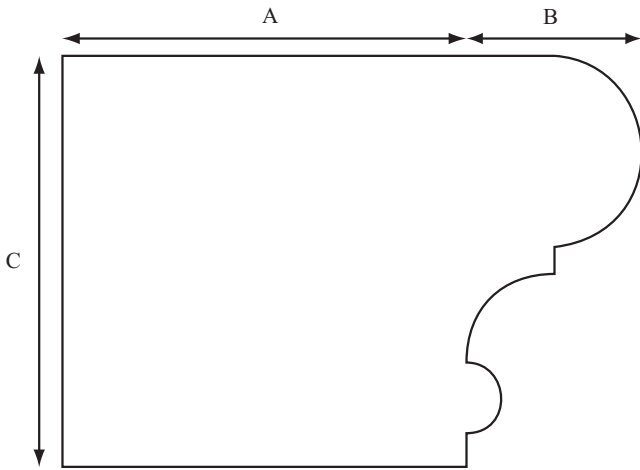

Item #	A	B	C
BG 013-3	3 5/8	1 1/2	3 5/8
BG 013-4	3 5/8	2	4 5/8
BG 013-5	3 5/8	2 7/16	5 5/8
BG 013-7	3 5/8	3 5/16	7 5/8

Item #	A	B	C
BG 014-3	3 5/8	1 1/2	3 5/8
BG 014-4	3 5/8	2	4 5/8
BG 014-5	3 5/8	2 7/16	5 5/8
BG 014-7	3 5/8	3 1/4	7 5/8

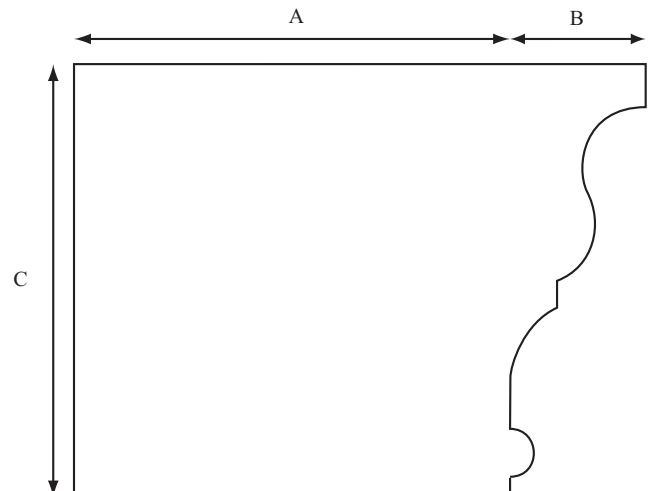
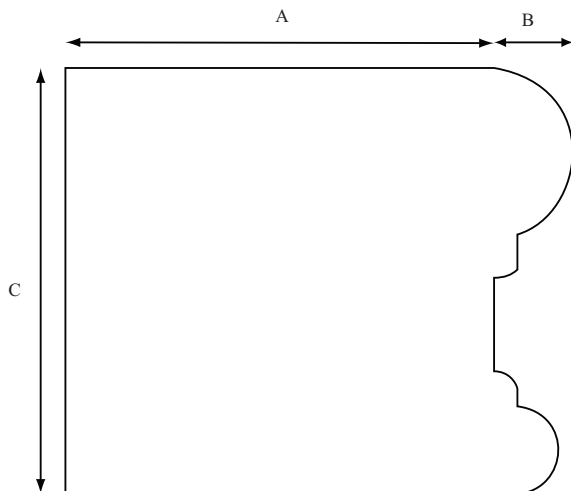

Item #	A	B	C
BG 015-3	3 5/8	5/8	3 5/8
BG 015-4	3 5/8	7/8	4 5/8
BG 015-5	3 5/8	1	5 5/8
BG 015-7	3 5/8	1 3/8	7 5/8

Item #	A	B	C
BG 016-3	3 5/8	1 1/8	3 5/8
BG 016-4	3 5/8	1 7/16	4 5/8
BG 016-5	3 5/8	1 3/4	5 5/8
BG 016-7	3 5/8	2 3/8	7 5/8

Custom profiles and sizes available.

Benabec

Architectural Products

Fireplaces

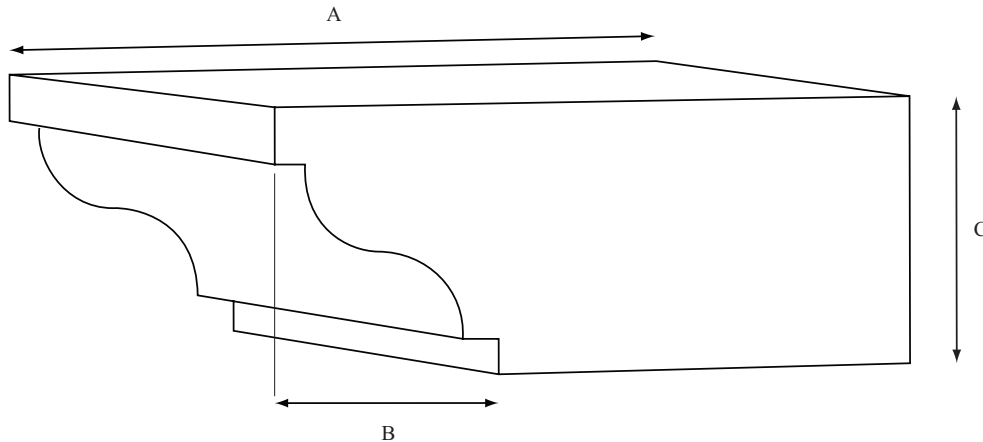

Item #	A	B	C
FPM 001	7 1/8	2 1/2	3

Standard length: 58"
Other lengths available

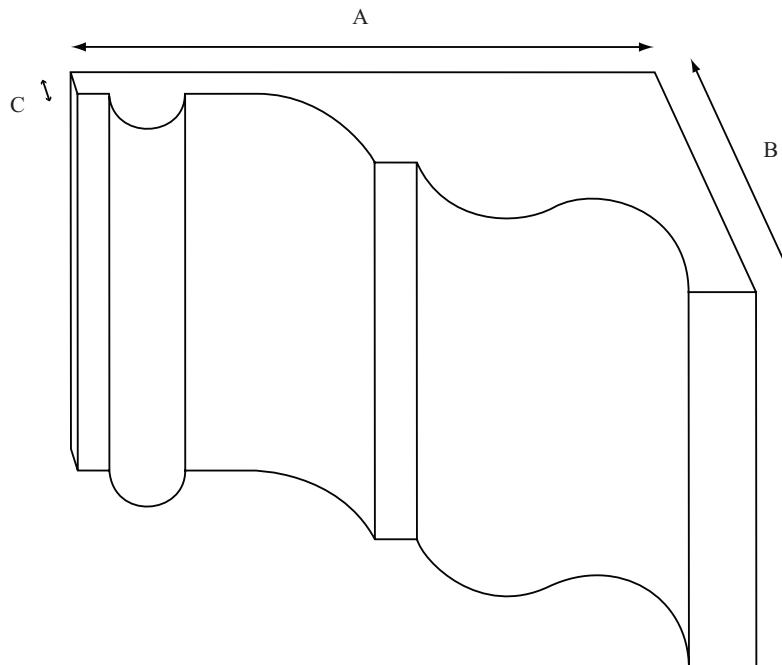

Item #	A	B	C
FPL 001	10	4 7/8	1 5/8
FPS 001	10	4 7/8	1 5/8

Standard height: 39 1/4"
Other heights available

Custom profiles and sizes available.

- Benabec is capable of manufacturing fireplace and mantel elements to lengths and profiles as required.
- Select a profile from any item in our catalogue or your own design.
- Choose a length, depth and thickness and we will quote you a price per foot.
- FPL denotes legs
- FPM denotes mantels
- FPS denotes surrounds

Custom profiles and sizes available.

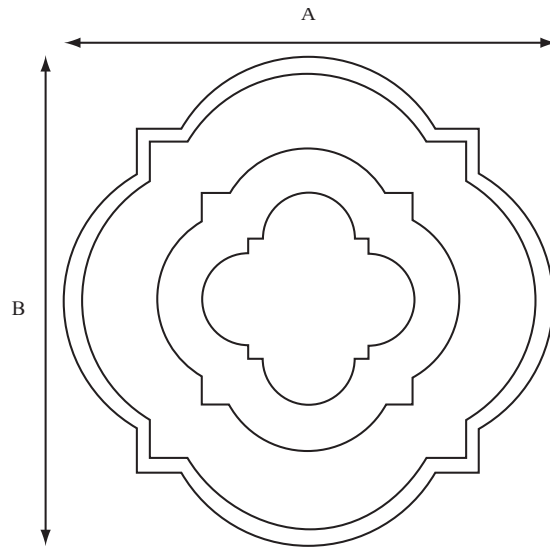

Item #	A	B	Depth	Profile
FO 001-2	26	26	3 5/8	1

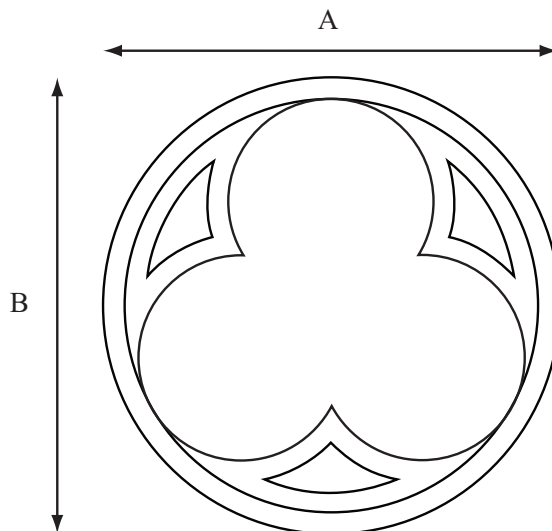

Item #	A	B	Depth	Profile
FO 002-3-2	24	24	3 5/8	1

Others sizes available.

Custom profiles and sizes available.

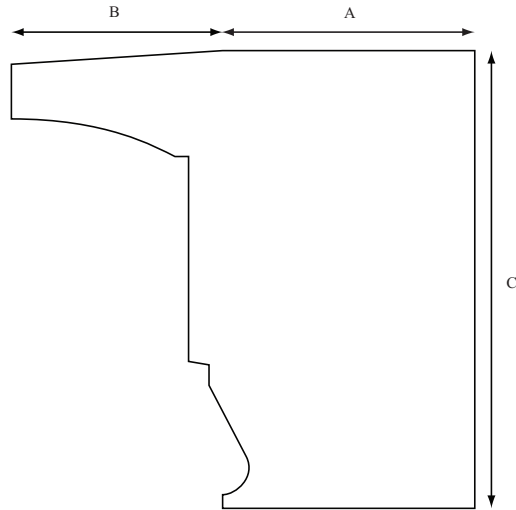

Item #	A	B	C
HDR 012	4 5/8	3 7/8	8 3/8

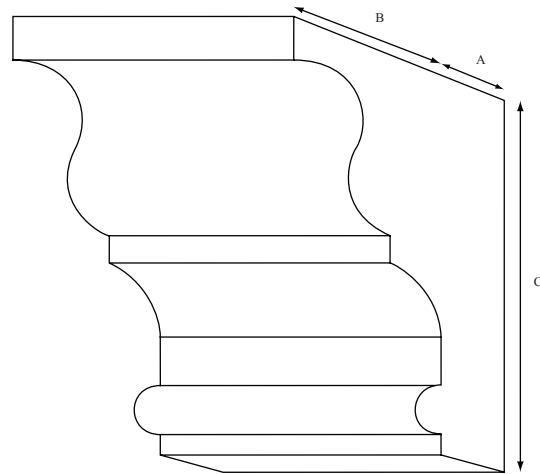

Item #	A	B	C
HDR 016-10	3 5/8	3	10

Custom profiles and sizes available.

Benabec

Architectural Products

Keystones

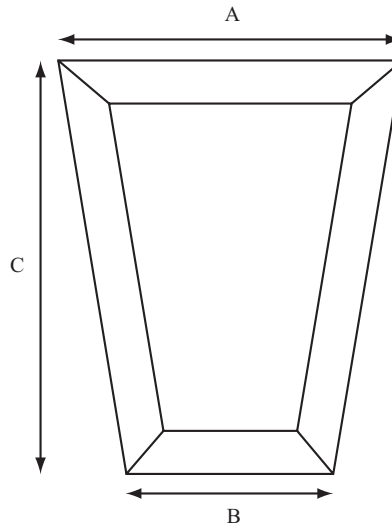

Item #	A	B	C	Depth	Profile
KS 001-05	5	3	6	3 5/8	3/4
KS 001-12	2	5 1/4	13 1/4	3 5/8	7/8

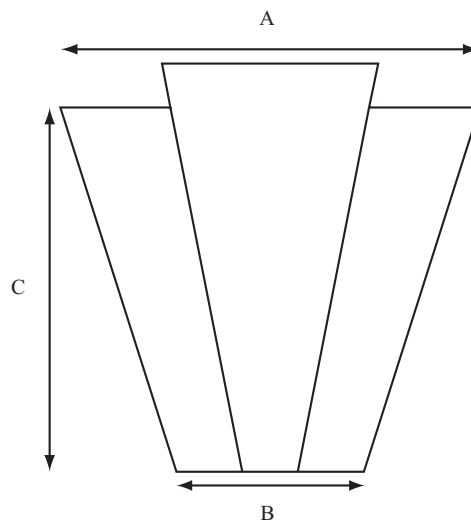

Item #	A	B	C	Depth	Profile
KS 002	9 1/2	4 1/4	9 1/4	3 5/8	1 5/8

Post Caps

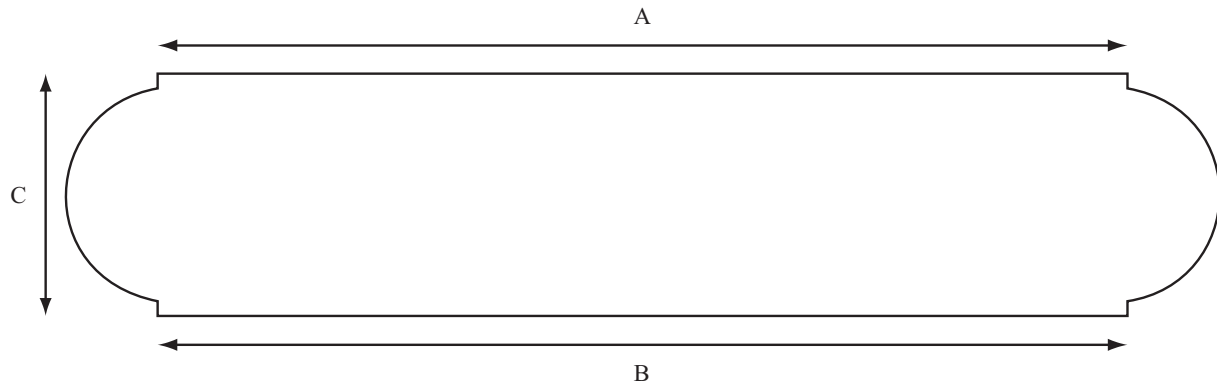

Item #	A	B	C
PCF 001-16	16	16	4
PCF 001-18	18	18	4
PCF 001-20	20	20	4
PCF 001-22	22	22	4

Other sizes available

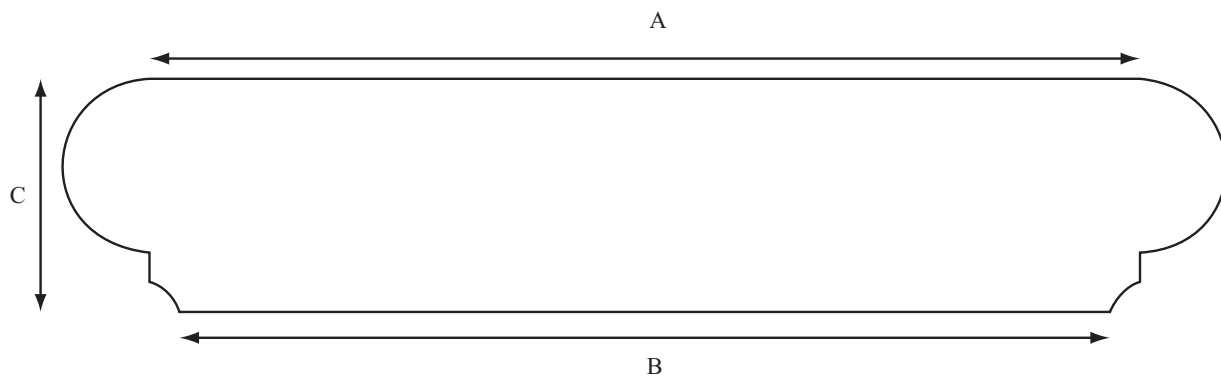

Item #	A	B	C
PCF 003-16	17	16	4
PCF 003-18	19	18	4
PCF 003-20	21	20	4
PCF 003-22	23	22	4
PCF 003-24	25	24	4

Other sizes available

Custom profiles and sizes available.

Benabec

Architectural Products

Post Caps

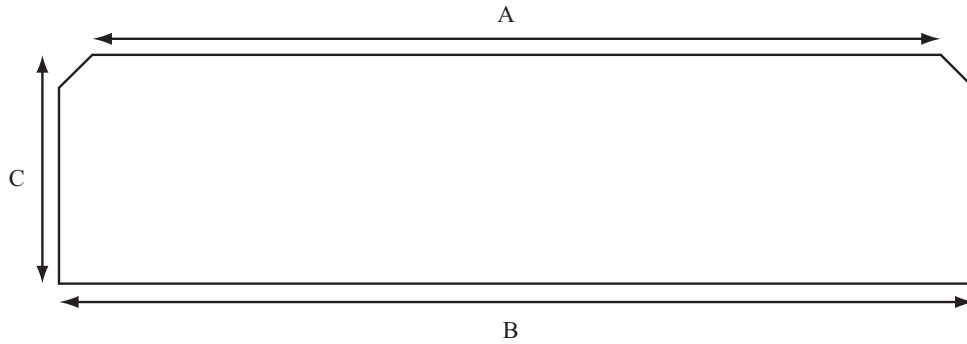

Item #	A	B	C
PCF 005-16	14 13/16	16	4
PCF 005-18	16 13/16	18	4
PCF 005-20	18 13/16	20	4
PCF 005-22	20 13/16	22	4
PCF 005-24	22 13/16	24	4

Other sizes available

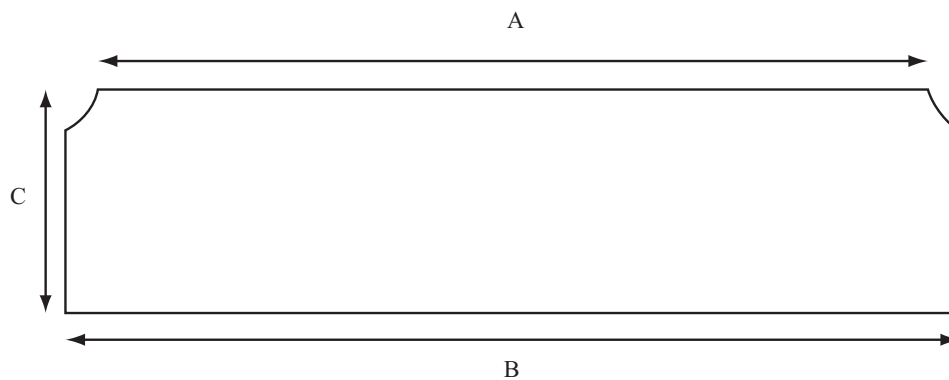

Item #	A	B	C
PCF 007-16	14 13/16	16	4
PCF 007-18	16 13/16	18	4
PCF 007-20	18 13/16	20	4
PCF 007-22	20 13/16	22	4
PCF 007-24	22 13/16	24	4

Other sizes available

Custom profiles and sizes available.

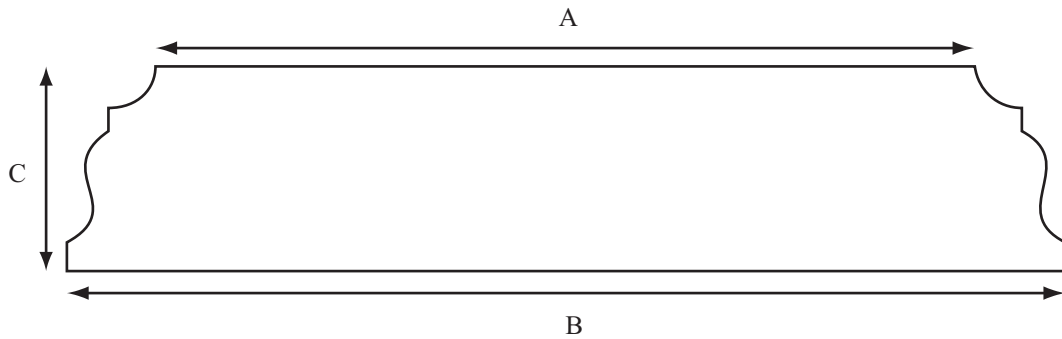

Item #	A	B	C
PCF 009-16	16	19 1/2	4
PCF 009-18	18	21 1/2	4
PCF 009-20	20	23 1/2	4
PCF 009-22	22	25 1/2	4
PCF 009-24	24	27 1/2	4

Other sizes available

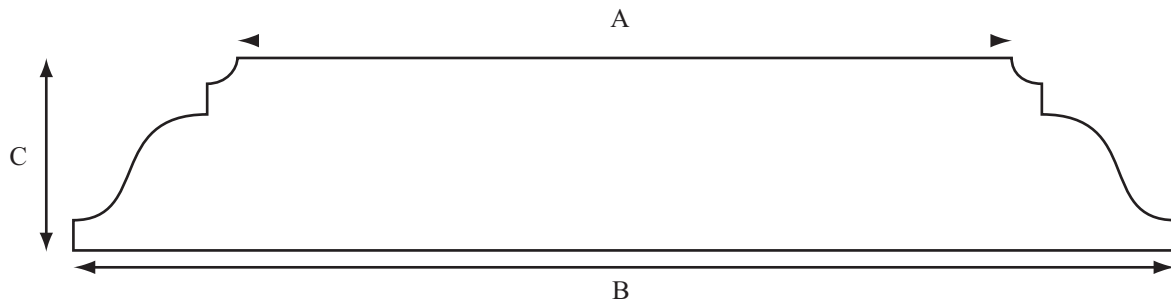

Item #	A	B	C
PCF 010-16	16	22 3/4	4
PCF 010-18	18	24 3/4	4
PCF 010-20	20	26 3/4	4
PCF 010-22	22	28 3/4	4
PCF 010-24	24	30 3/4	4

Other sizes available

Custom profiles and sizes available.

Benabec

Architectural Products

Post Caps

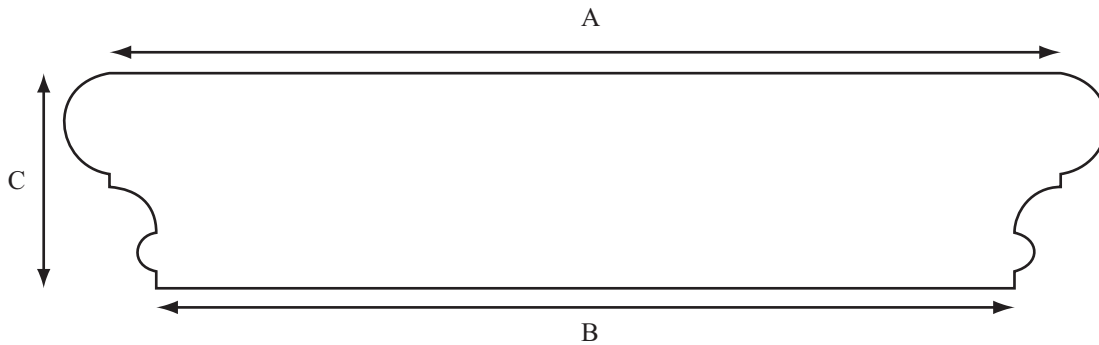

Item #	A	B	C
PCF 013-16	17 3/4	16	4
PCF 013-18	19 3/4	18	4
PCF 013-20	21 3/4	20	4
PCF 013-22	23 3/4	22	4
PCF 013-24	25 3/4	24	4

Other sizes available

Custom profiles and sizes available.

Benabec

Architectural Products

Sills

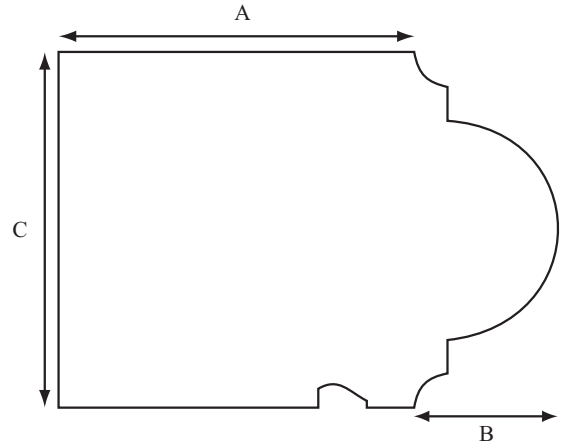
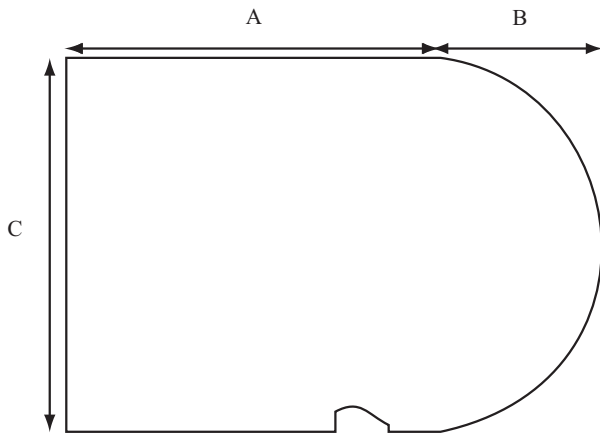

Item #	A	B	C
SI 001-3	5	1 1/2	3 5/8
SI 001-4	5	2	4 5/8
SI 001-5	5	2 13/32	5 5/8
SI 001-7	5	3 1/4	7 5/8

Item #	A	B	C
SI 002-3	5	1 1/2	3 5/8
SI 002-4	5	1 7/8	4 5/8
SI 002-5	5	2 1/4	5 5/8
SI 002-7	5	3	7 5/8

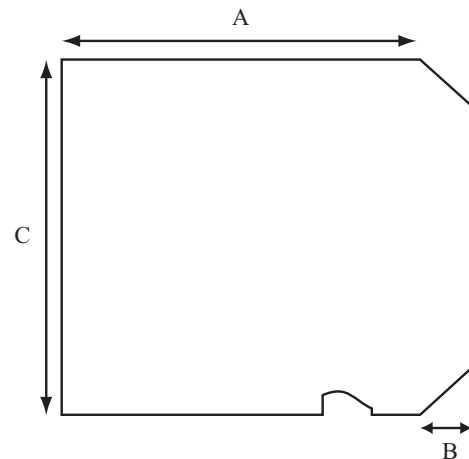
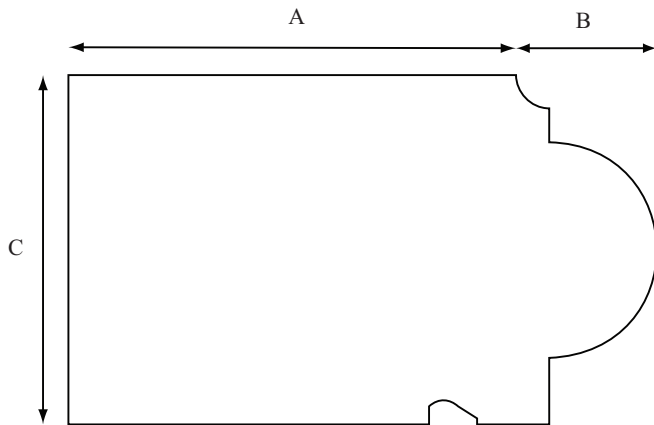

Item #	A	B	C
SI 003-3	5	1 1/2	3 5/8
SI 003-4	5	1 7/8	4 5/8
SI 003-5	5	2 1/4	5 5/8
SI 003-7	5	3	7 5/8

Item #	A	B	C
SI 004-3	5	1/2	3 5/8
SI 004-4	5	11/16	4 5/8
SI 004-5	5	13/16	5 5/8
SI 004-7	5	1 1/8	7 5/8

Custom profiles and sizes available.

Benabec

Architectural Products

Sills

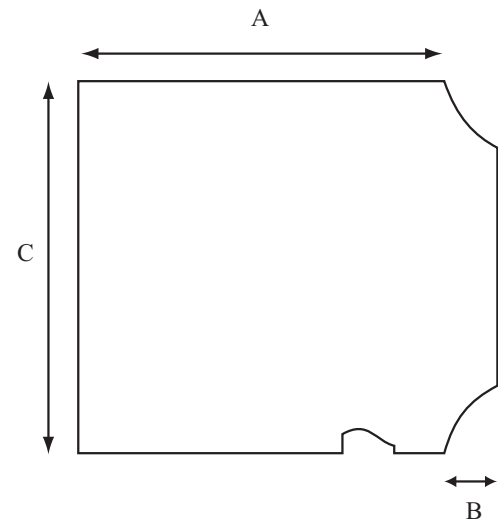
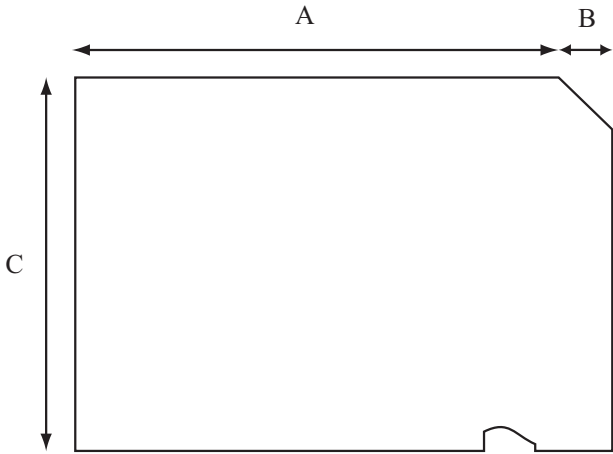

Item #	A	B	C
SI 005-3	5	1/2	3 5/8
SI 005-4	5	11/16	4 5/8
SI 005-5	5	13/16	5 5/8
SI 005-7	5	1 1/8	7 5/8

Item #	A	B	C
SI 006-3	5	1/2	3 5/8
SI 006-4	5	11/16	4 5/8
SI 006-5	5	13/16	5 5/8
SI 006-7	5	1 1/8	7 5/8

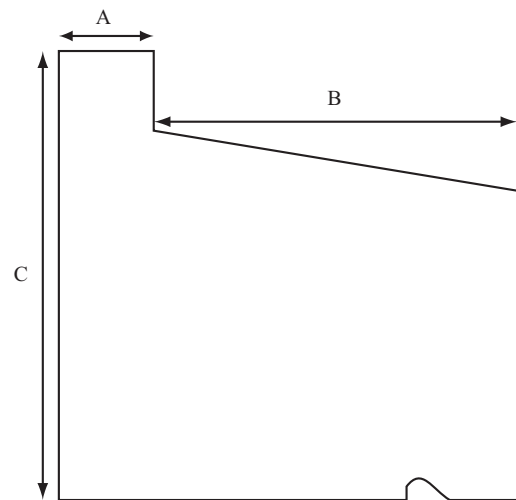
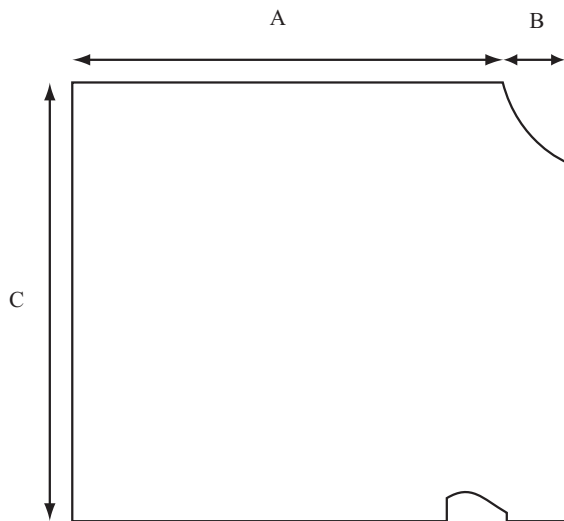

Item #	A	B	C
SI 007-3	5	1/2	3 5/8
SI 007-4	5	11/16	4 5/8
SI 007-5	5	13/16	5 5/8
SI 007-7	5	1 1/8	7 5/8

Item #	A	B	C	D
SI 008-3	1	4 1/8	5	3 5/8

D - width of brick lug
Other sizes available

Custom profiles and sizes available.

Benabec

Architectural Products

Sills

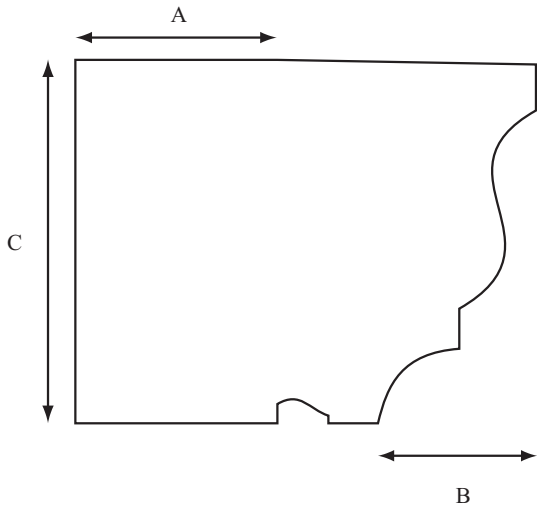

Item #	A	B	C
SI 009-3	5	1 1/2	3 5/8
SI 009-4	5	2	4 5/8
SI 009-5	5	2 7/16	5 5/8
SI 009-7	5	3 5/16	7 5/8

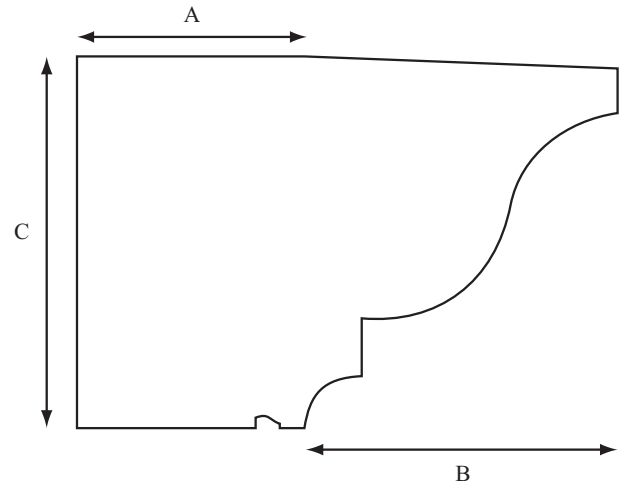

Item #	A	B	C
SI 010-3	5	3	3 5/8
SI 010-4	5	3 7/8	4 5/8
SI 010-5	5	4 3/4	5 5/8
SI 010-7	5	6 7/16	7 5/8

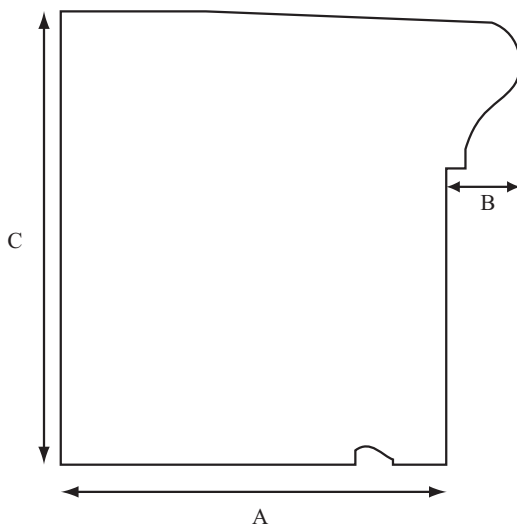

Item #	A	B	C
SI 011	5 3/16	1	6 1/8

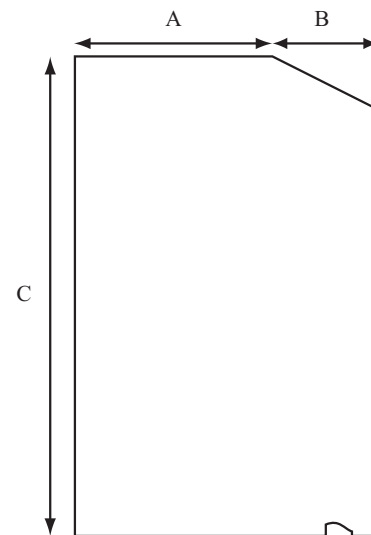

Item #	A	B	C
SI 012-4	3 5/8	2	4 1/4
SI 012-9	3 5/8	2	9

Custom profiles and sizes available.

Benabec

Architectural Products

Sills

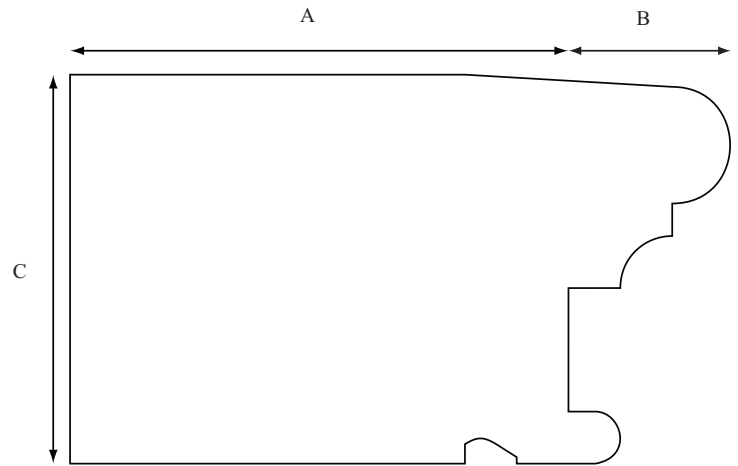
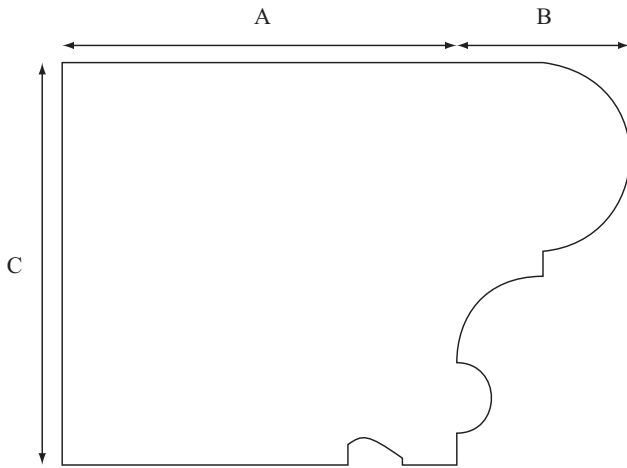

Item #	A	B	C
SI 013-3	5	1 1/16	3 5/8
SI 013-4	5	2	4 5/8
SI 013-5	5	2 7/16	5 7/8
SI 013-7	5	3 5/16	7 5/8

Item #	A	B	C
SI 014-3	5	1 1/2	3 5/8
SI 014-4	5	2	4 5/8
SI 014-5	5	2 1/4	5 5/8
SI 014-7	5	3 3/16	7 5/8

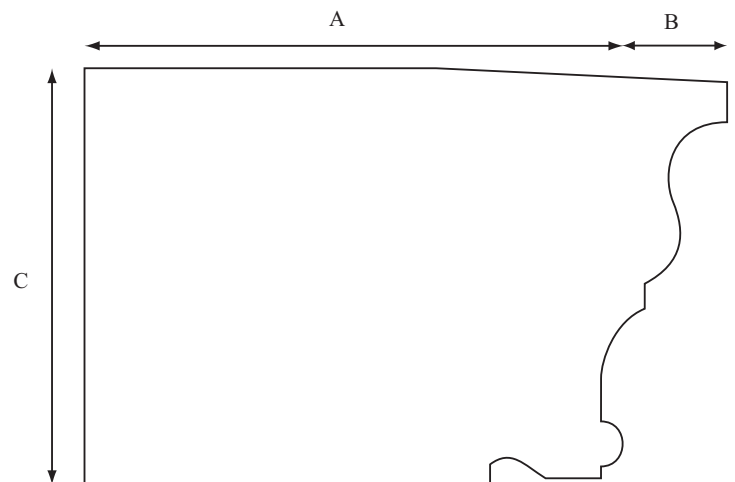
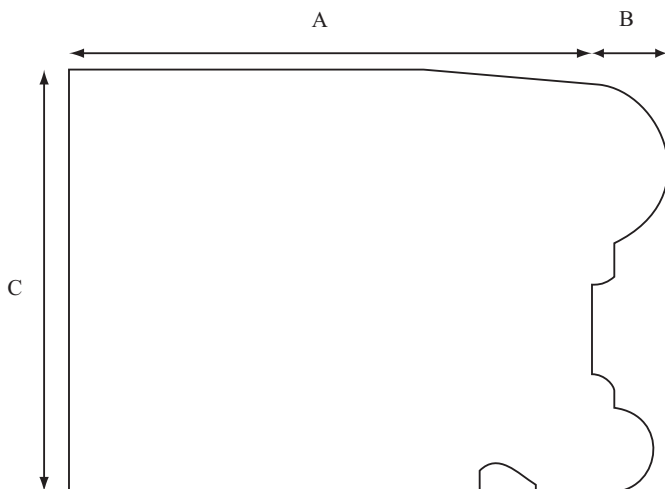

Item #	A	B	C
SI 015-3	5	5/8	3 5/8
SI 015-4	5	7/8	4 5/8
SI 015-5	5	1	5 5/8
SI 015-7	5	1 3/8	7 5/8

Item #	A	B	C
SI 016-3	5	1	3 5/8
SI 016-4	5	1 3/8	4 5/8
SI 016-5	5	1 11/16	5 5/8
SI 016-7	5	2 5/16	7 5/8

Custom profiles and sizes available.

Benabec

Architectural Products

Step Treads

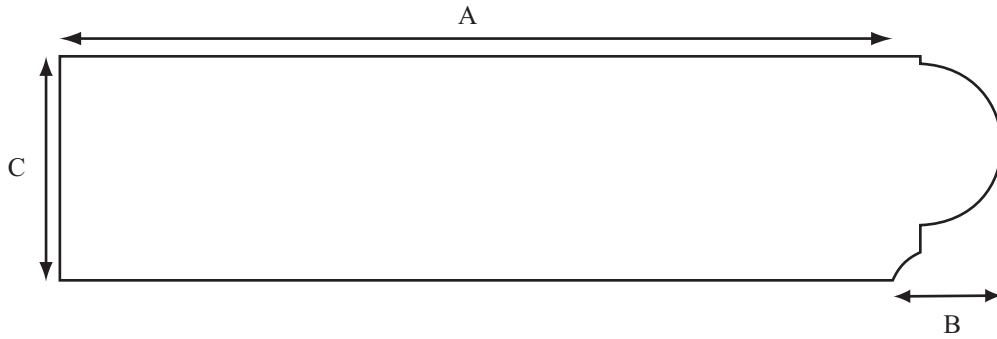

Item #	A	B	C
ST 003	custom	1 3/8	3 3/4

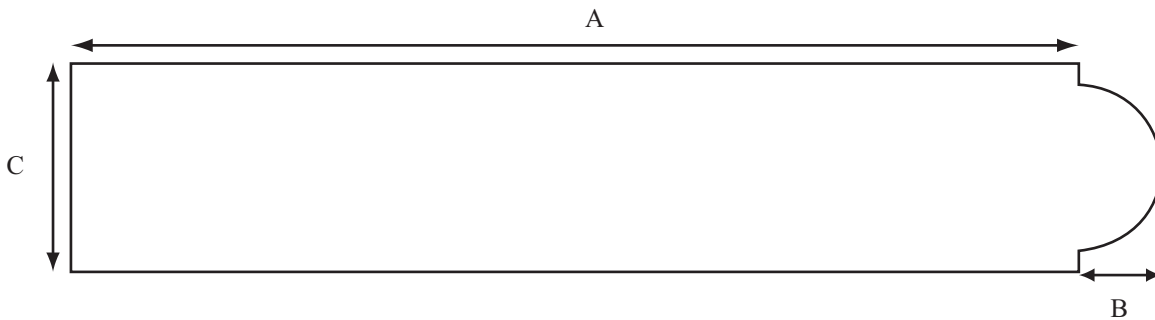

Item #	A	B	C
ST 001	custom	15/16	3 5/16

Custom profiles and sizes available.

Benabec

Architectural Products

Surrounds

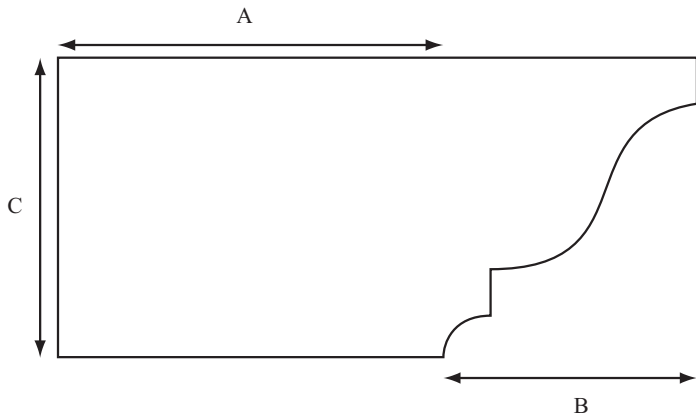

Item #	A	B	C
SU 010-3	3 5/8	3	3 5/8
SU 010-4	3 5/8	3 7/8	4 5/8
SU 010-5	3 5/8	4 3/4	5 5/8
SU 010-7	3 5/8	6 7/16	7 5/8

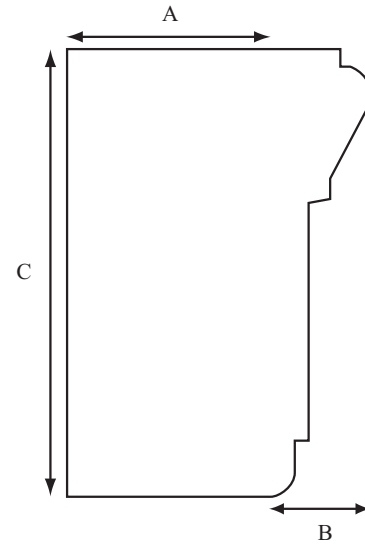

Item #	A	B	C
SU 011	3 5/8	1 13/16	8

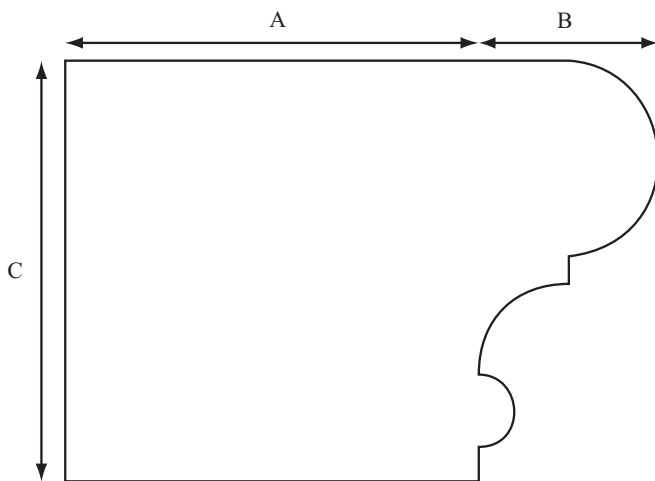

Item #	A	B	C
SU 013-3	3 5/8	1 1/2	3 5/8
SU 013-4	3 5/8	2	4 5/8
SU 013-5	3 5/8	2 7/16	5 5/8
SU 013-7	3 5/8	3 5/16	7 5/8

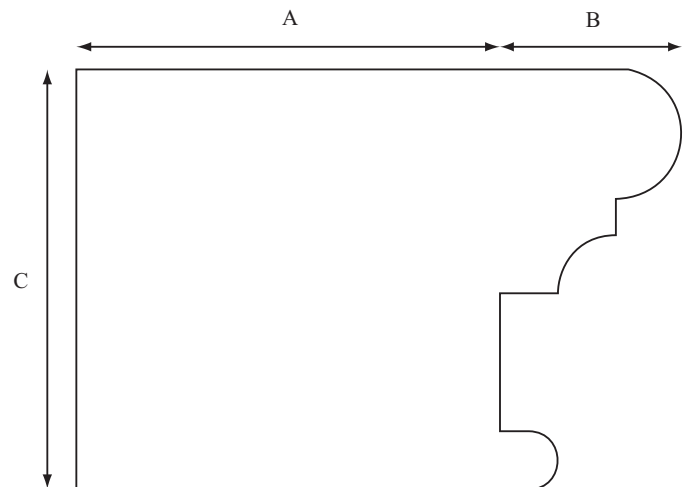

Item #	A	B	C
SU 014-3	3 5/8	1 1/2	3 5/8
SU 014-4	3 5/8	2	4 5/8
SU 014-5	3 5/8	2 7/16	5 5/8
SU 014-7	3 5/8	3 1/4	7 5/8

Custom profiles and sizes available.

Benabec

Architectural Products

Surrounds

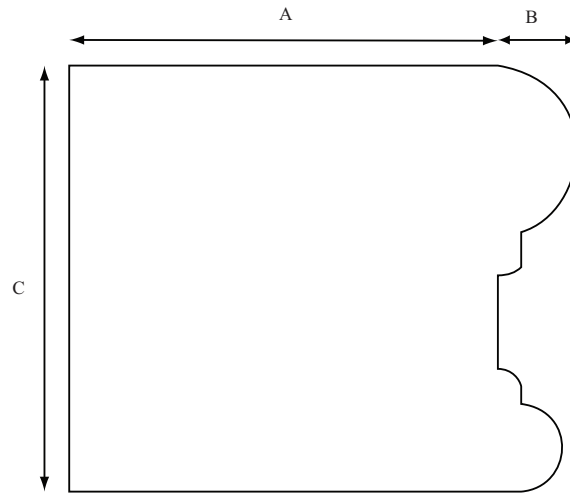

Item #	A	B	C
SU 015-3	3 5/8	5/8	3 5/8
SU 015-4	3 5/8	7/8	4 5/8
SU 015-5	3 5/8	1	5 5/8
SU 015-7	3 5/8	1 3/8	7 5/8

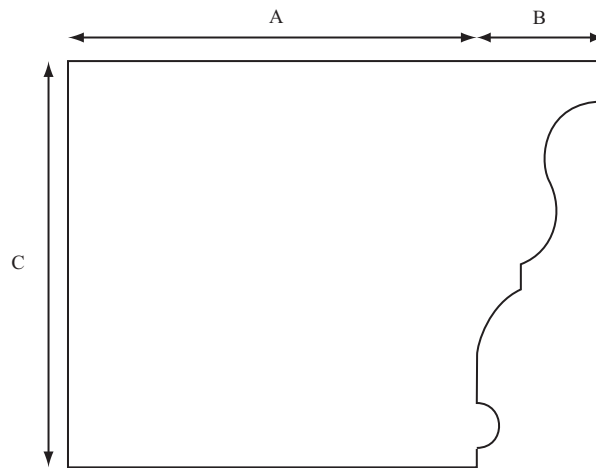

Item #	A	B	C
SU 016-3	3 5/8	1 1/8	3 5/8
SU 016-4	3 5/8	1 7/16	4 5/8
SU 016-5	3 5/8	1 3/4	5 5/8
SU 016-7	3 5/8	2 3/8	7 5/8
SU 016-10	3 5/8	3	10

Custom profiles and sizes available.

- Benabec is capable of manufacturing threshold elements to lengths and profiles as required.
- Select a profile from any item in our catalogue or your own design.
- Choose a length, depth and thickness and we will quote you a price per foot.

Custom profiles and sizes available.

- Benabec is capable of manufacturing wallcapping elements to lengths and profiles as required.
- Select a profile from any item in our catalogue or your own design.
- Choose a length, depth and thickness and we will quote you a price per foot.

Custom profiles and sizes available.

Benabec

Architectural Products

Watertables

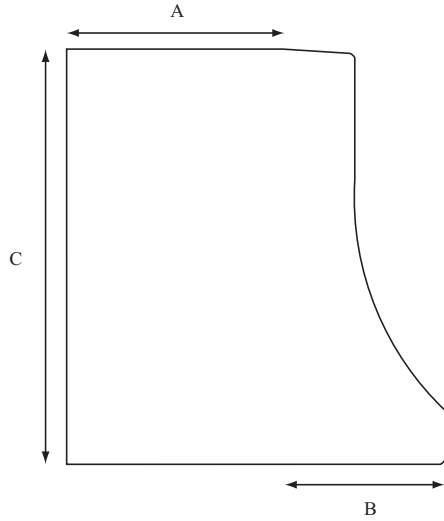

Item #	A	B	C
WT 011	3	2 1/4	5 3/4

Custom profiles and sizes available.

Benabec

Architectural Products

Collections: Soper Series

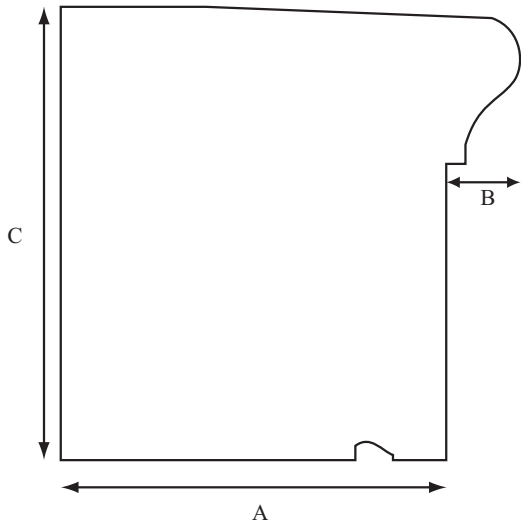

Item #	A	B	C
SI 011	5 3/16	1	6 1/8

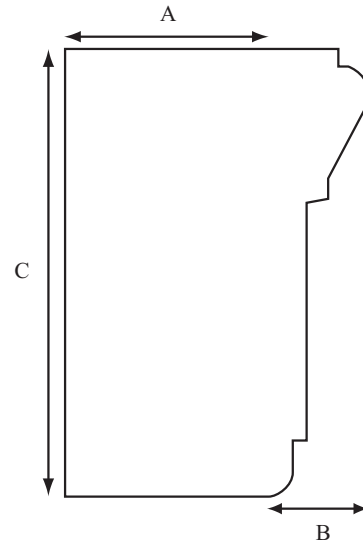

Item #	A	B	C
SU 011	3 5/8	1 13/16	8

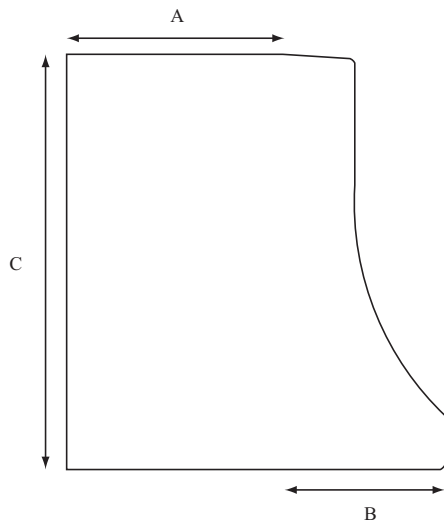

Item #	A	B	C
WT 011	3	2 1/4	5 3/4



Custom profiles and sizes available.

Benabec Architectural Cast Stone Design Specification

Materials of Construction

1. Portland Cement: ASTM C 150 Type 10 ; Colour to be white or gray as required to achieve proper colour match as determined by customer specifications.
2. Aggregate: ASTM C 33 ; Coarse and fine aggregate may be white or darker in colour as required to achieve proper colour match as determined by customer specifications.
3. Pigments: ASTM C 979; Inorganic, non-fading, resistant to lime and other alkalis. Pigments not to exceed 10% of cement weight.
4. Water: Potable, free from foreign materials in amounts harmful to concrete or steel within the casting.
5. Air Entrainment Admixture: ASTM C 260
6. Reinforcement: Reinforcing bars as necessary for safe handling, setting and structural stress and where specified by customer will be epoxy coated. The size of the reinforcing shall be a minimum area of steel equal to one quarter of one percent of the cross section area.
7. Surface Colour: Match sample on file in architect's office when applicable.

Custom profiles and sizes available.

Benabec

Architectural Products

Specifications

8. **Surface Finish:** Units shall exhibit a texture approximately equal to the approved sample when viewed under a direct daylight illumination at a distance of 10 ft. (3m) distance.
All surfaces intended to be exposed to view, shall have a contiguous texture as specified by customer or as submitted for approval to architect. There shall be no voids in excess of 1/32 in. and not be obvious from a distance of not less than 5 ft. Minor chipping resulting from shipping, shall not be grounds for rejection. Minor chips shall not be obvious from a distance of 20ft. in direct daylight illumination.
The occurrence of crazing or efflorescence shall not be cause for rejection.
9. **Curing:** Cure elements in a moist area of as close to 95% relative humidity as reasonable for approximately 12 hours at a minimum of 70 F after casting. Additional yard curing of 7 days at 50 F or 5 days at 70 F .
10. **Manufacturing Tolerances:** Cross section dimensions, overall length of units or warp, bow and twist of units shall not deviate by more than +/- 1/8 in. from approved dimensions.
11. **Examination:** It is the responsibility of the customer, upon receipt of units to examine them for approved finish and fit. Do not set unacceptable units. Once defective or unacceptable units have been set it is the sole responsibility of the contractor/customer to cover all replacement costs to be incurred.

Custom profiles and sizes available.

Benabec

Architectural Products

Notes & Sketches

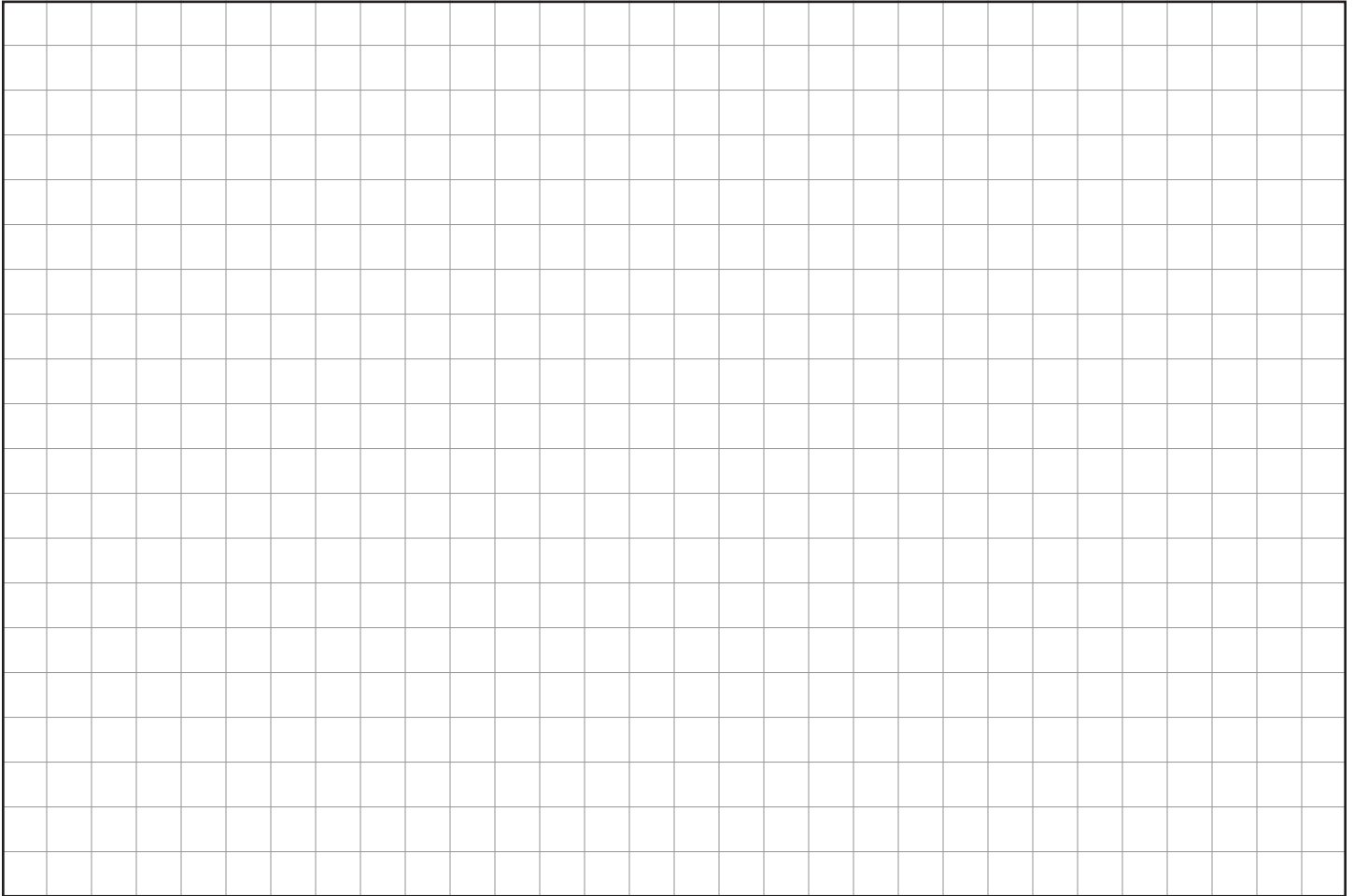

Design & layout provided by:



email: stylishdesigns@rogers.com